

GPS+LTE+WIFI Combination Antenna JCE072

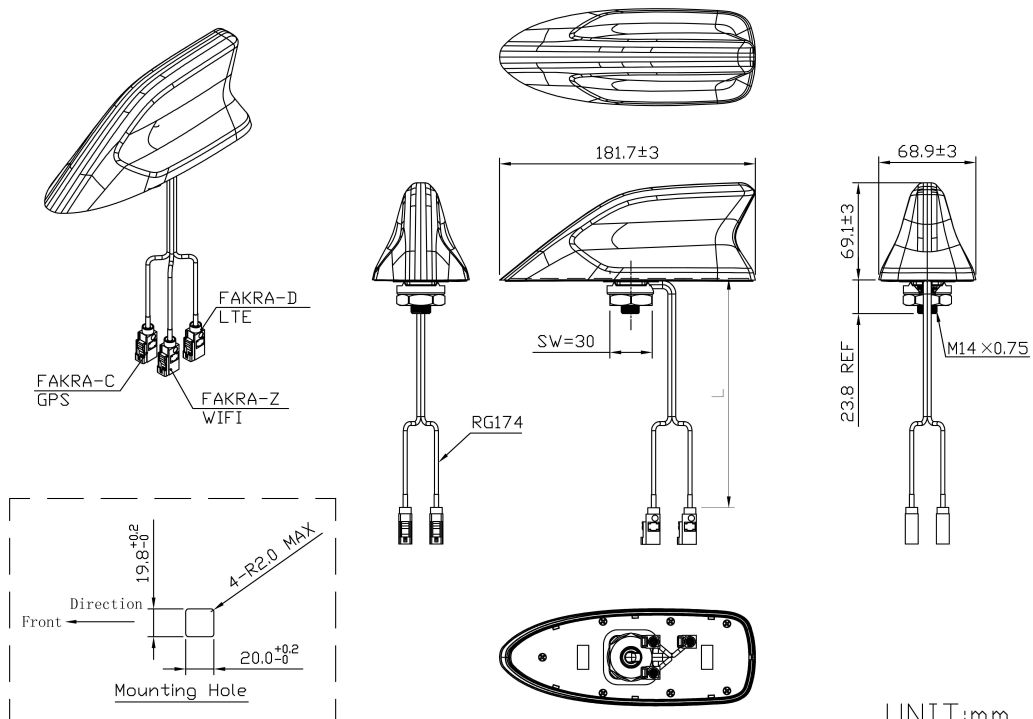

DIMENSIONS



JIAXING JINCHANG ELECTRONIC TECHNOLOGY CO.,LTD

Add: 398#, Zhenye Road, South Street, Jiaxing, Zhejiang, China

Http:// www.jinchanggps.com

E-mail: jcgps@vip.163.com

Tel: 86-0573-83692157/83692605/83958637 Fax: 86-0573-83958635

SPECIFICATIONS

Item		Specifications	
GPS Antenna	Dielectric Antenna	Center Frequency	1575.42±3MHz
		Polarization	RHCP
		Gain	2dBic (Zenith)
		V.S.W.R	<1.5
		Impedance	50Ω
	LNA	Gain	28±2dB
		Noise Figure	<2.0dB
		V.S.W.R	<2.0
		Supply Voltage	3~5V DC
		Current Consumption	5~15mA
LTE Antenna	Frequency Range	698~960/MHz/1710~2690MHz	
	V.S.W.R	<3.0	
	Polarization	Linear	
	Gain	3.5dBi (Zenith)	
	Impedance	50Ω	
WIFI Antenna	Frequency Range	2400~2483.5MHz	
	V.S.W.R	<2.0	
	Polarization	Linear	
	Gain	3.0dBi (Zenith)	
	Impedance	50Ω	
Mechanical	Cable	RG174	
	Connector	FAKRA or others	
	Mounting Method	Screw	
Environmental	Operating Temperature	-40℃~+85℃	
	Relative Humidity	Up to 95%	
	Ingress Protection	IP67(exclude cable outlet)	
	Vibration	10 to 1000Hz G=28.7m/s ²	
	Environmentally Friendly	ROHS Compliant	

Radiation Pattern

GPS Antenna

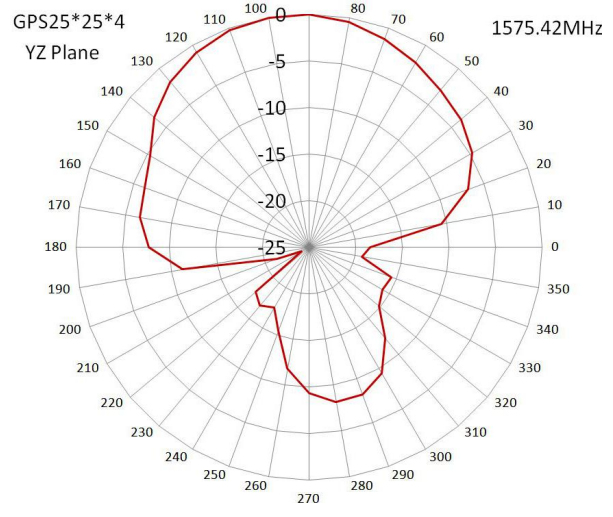
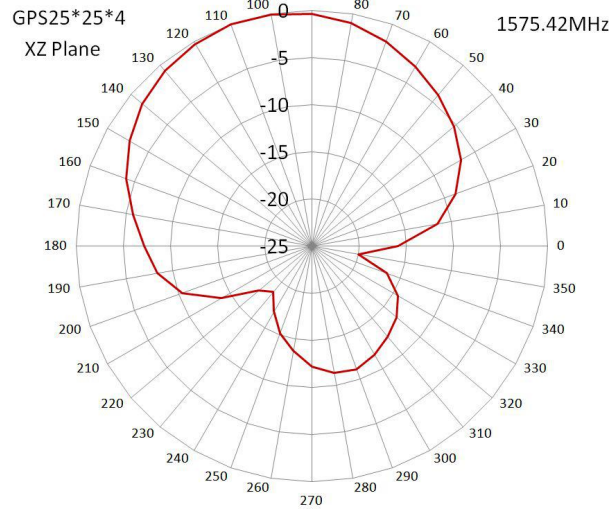
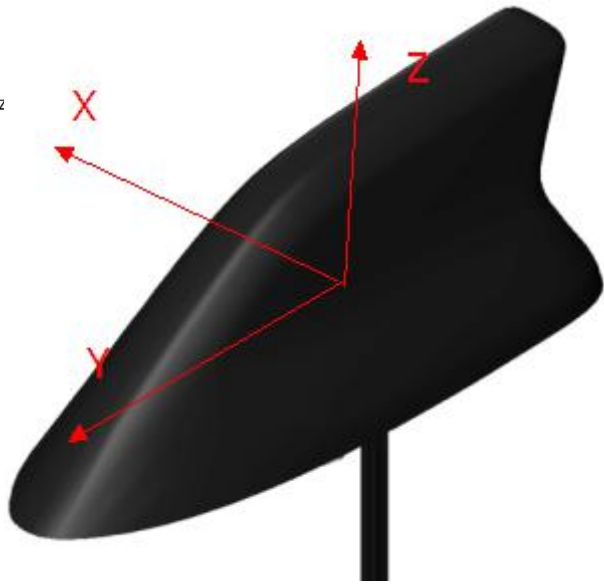
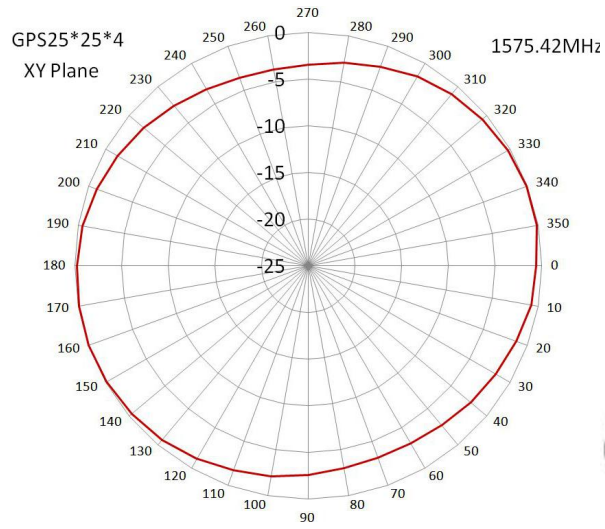

LTE Antenna

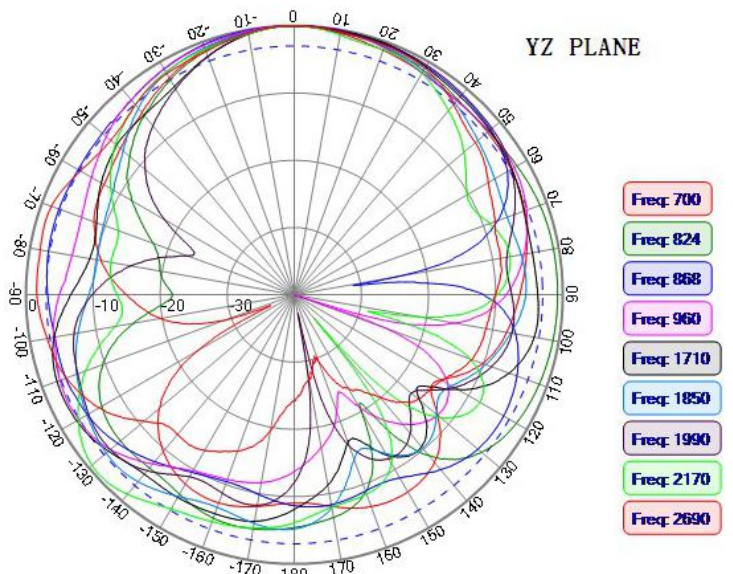
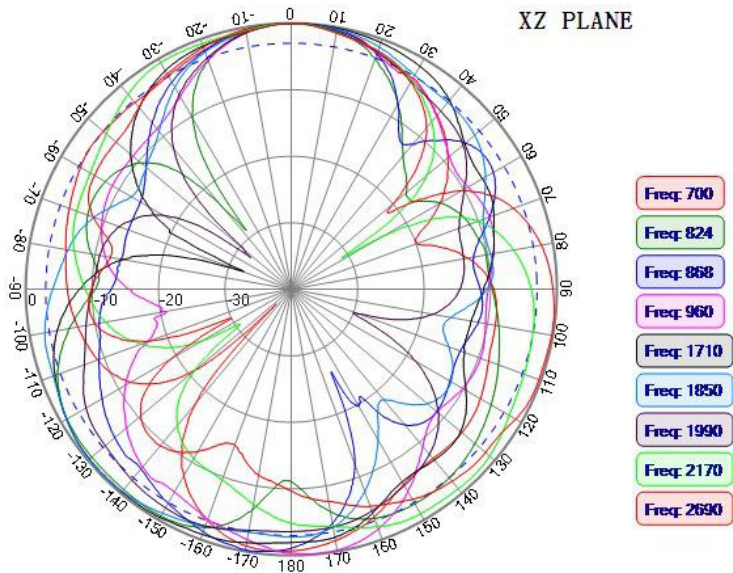
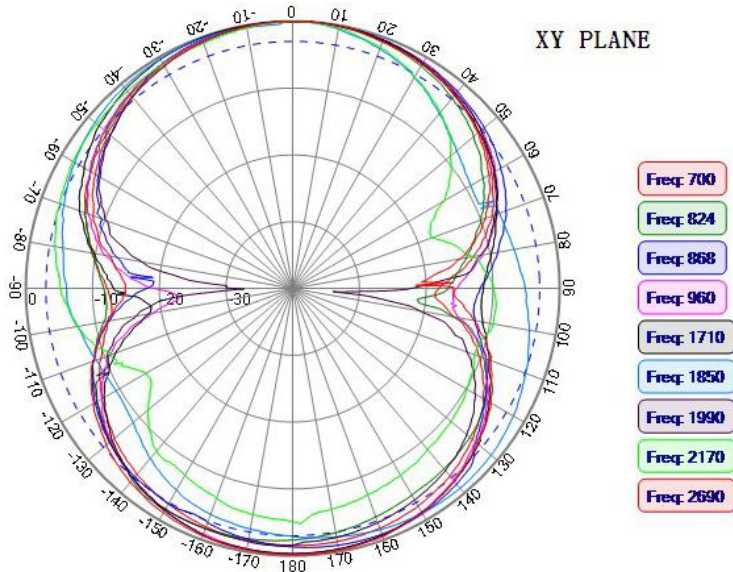

WIFI Antenna

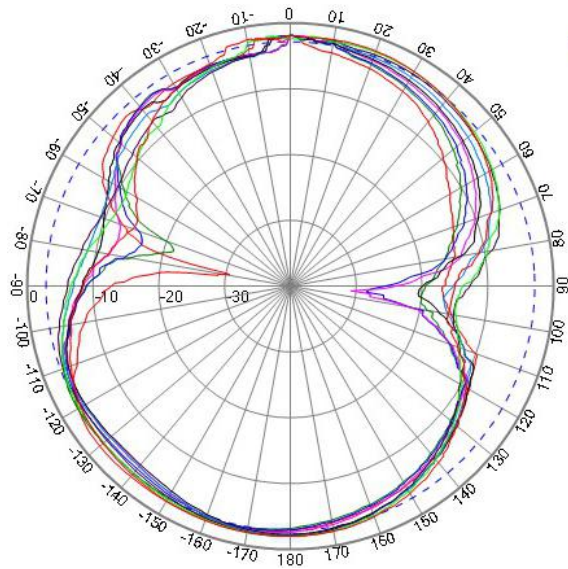

XY PLANE

- Freq: 2400
- Freq: 2410
- Freq: 2420
- Freq: 2430
- Freq: 2440
- Freq: 2450
- Freq: 2460
- Freq: 2470
- Freq: 2483

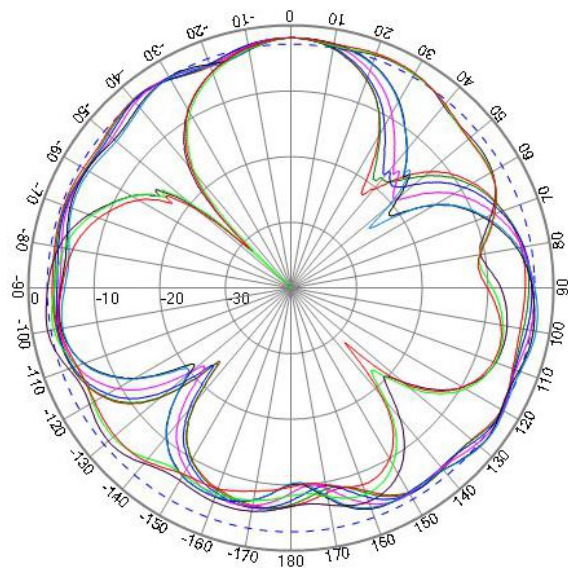

XZ PLANE

- Freq: 2400
- Freq: 2410
- Freq: 2420
- Freq: 2430
- Freq: 2440
- Freq: 2450
- Freq: 2460
- Freq: 2470
- Freq: 2483

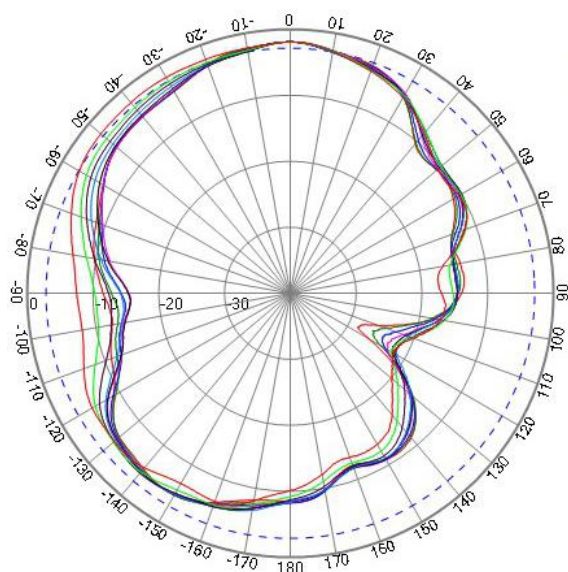

YZ PLANE

- Freq: 2400
- Freq: 2410
- Freq: 2420
- Freq: 2430
- Freq: 2440
- Freq: 2450
- Freq: 2460
- Freq: 2470
- Freq: 2483