



# UR32

## Quick Start Guide



## Welcome

Thank you for choosing Milesight UR32 industrial cellular router.

This guide describes how to install the UR32 and how to log in the Web GUI to configure the device. Once you complete the installation, refer to the Milesight UR32 User Guide for instructions on how to perform configurations on the device.

## Related Documents

This Start Guide only explains the installation of Milesight UR32 router. For more functionality and advanced settings, please refer to the relevant documents as below.

Document	Description
UR32 Datasheet	Datasheet for UR32 industrial cellular router.
UR32 User Guide	Users could refer to the guide for instruction on how to log in the web GUI, and how to configure all the settings.

The related documents are available on Milesight website: <https://www.milesight-iot.com>

## Declaration of Conformity

UR32 are in conformity with the essential requirements and other relevant provisions of the CE, FCC, and RoHS.



© 2011-2021 Xiamen Milesight IoT Co., Ltd.

### All rights reserved.

All information in this guide is protected by copyright law. Whereby, no organization or individual shall copy or reproduce the whole or part of this user guide by any means without written authorization from Xiamen Milesight IoT Co., Ltd.

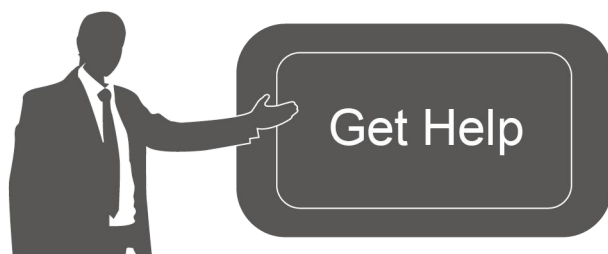

For assistance, please contact  
Milesight technical support:  
Email: [iot.support@milesight.com](mailto:iot.support@milesight.com)  
Tel: 86-592-5085280  
Fax: 86-592-5023065

## Revision History

Date	Doc Version	Description
Apr. 26, 2019	V 1.0	Initial version
May 11, 2020	V 1.1	Web interfaces upgrade
Nov. 25, 2020	V 2.0	Layout Replace

# 1. Packing List

Before you begin to install the UR32 router, please check the package contents to verify that you have received the items below.



1 × UR32

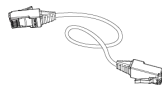

1 × Ethernet Cable

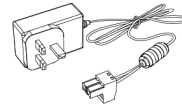

1 × Power Adapter



2 × Magnetic Cellular Antennas



1 × 6-Pin Pluggable Terminal

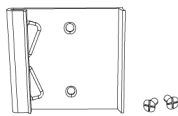

1 × DIN Rail Kit

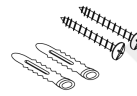

4 × Setscrews



1 × Warranty Card

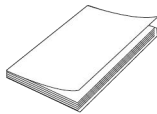

1 × Quick Start Guide



1 × Stubby Wi-Fi Antenna (Wi-Fi Version Only)



1 × GPS Antenna (GPS Version Only)

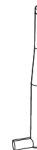

2 × Stubby Cellular Antennas (Optional)



**If any of the above items is missing or damaged, please contact your sales representative.**

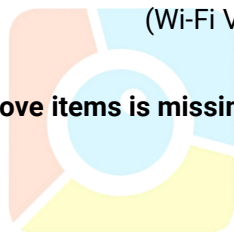

## 2. Hardware Introduction

### 2.1 Overview

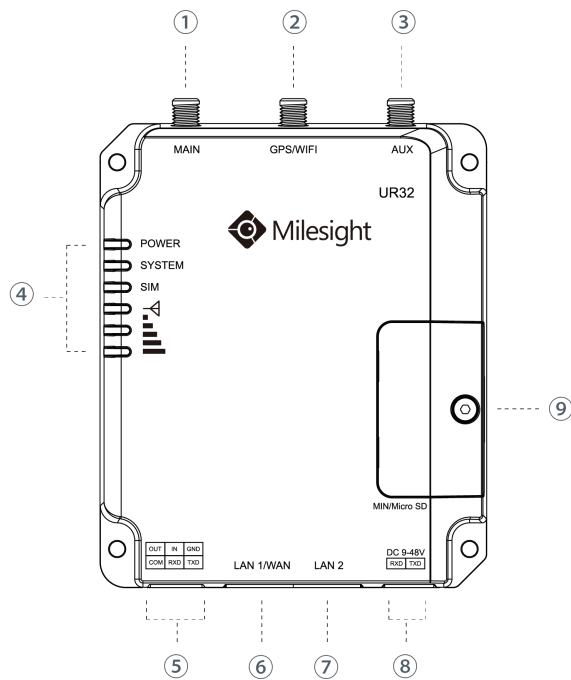

- ① Main Cellular Antenna Connector
- ② GPS/WIFI Antenna Connector
- ③ AUX Cellular Antenna
- ④ LED Indicator Area  
POWER: Power Indicator  
SYSTEM: Status Indicator  
SIM : Status Indicator  
∇: Signal Strength Indicator
- ⑤ Serial Port & I/O
- ⑥ Ethernet LAN1/WAN Port
- ⑦ Ethernet LAN2 Port
- ⑧ Power Connector
- ⑨ SIM and Reset Button Holder

### 2.2 Dimensions (mm)

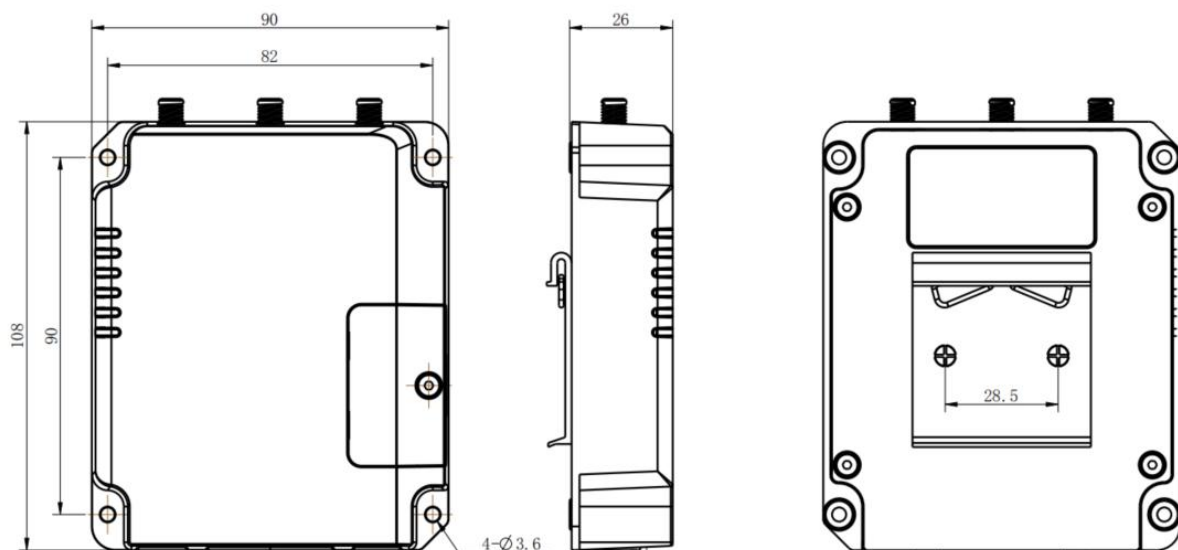

## 2.3 Connectors

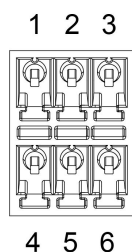

PIN	RS232	RS485*	DI	DO	Description
1	---	---	---	OUT	Digital Output
2	---	---	IN	---	Digital Input
3	GND	---	---	---	Ground
4	---	---	COM	COM	Common Ground
5	RXD	B	---	---	Receive Data
6	TXD	A	---	---	Transmit Data



7 8

PIN	Description
7	Positive
8	Negative

\*: Only for -485 model.

## 2.4 LED Indicators

LED	Indication	Status	Description
POWER	Power Status	Off	The power is switched off
		On	The power is switched on
SYSTEM	System Status	Green Light	Static: Start-up Blinking slowly: the system is running properly
		Red Light	The system goes wrong
		Off	
SIM	SIM Card Status	Off	SIM1 or SIM2 is registering or fails to register (or there are no SIM cards inserted)
		Green Light	Blinking slowly: SIM1 has been registered and is ready for dial-up Blinking rapidly: SIM1 has been registered and is dialing up now
		Off	Static: SIM1 has been registered and dialed up successfully
		Orange Light	Blinking slowly: SIM2 has been registered and is ready for dial-up Blinking rapidly: SIM2 has been registered and is dialing up now
		Off	Static: SIM2 has been registered and dialed up successfully
		Off	
Signal Strength	Signal 1/2/3	Off	No signal
		Green Light	Static/Off/Off: weak signals with 1-10 ASU (please check if the antenna is installed correctly, or move the antenna to a suitable location to get better signal)

			Static/Static/Off: normal signals with 11-20 ASU (average signal strength)
			Static/Static/Static: strong signals with 21-31 ASU (signal is good)

## 2.5 Reset Button

Reset button is under the SIM slots.

Function	Description	
	SYSTEM LED	Action
Reset	Blinking	Press and hold the reset button for more than 5 seconds.
	Static Green → Rapidly Blinking	Release the button and wait.
	Off → Blinking	The router is now reset to factory defaults.

## 2.6 Ethernet Port Indicator

Indicator	Status	Description
Link Indicator (Orange)	On	Connected
	Blinking	Transmitting data
	Off	Disconnected



### 3. Hardware Installation

#### Environmental Requirements

- Power Input: 9-48 VDC
- Power Consumption: Typical 1.9W (Max 2.4 W)
- Operating Temperature: -40°C to 70°C (-40°F -158°F)
- Relative Humidity: 0% to 95% (non-condensing) at 25°C/77°F

#### 3.1 SIM Card/Micro SD Card Installation

A. Unscrew the cover of the SIM card then screw it up.

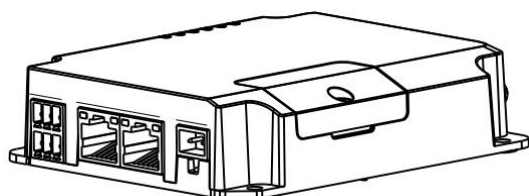

B. Put SIM card/Micro SD into the slot and take it off.

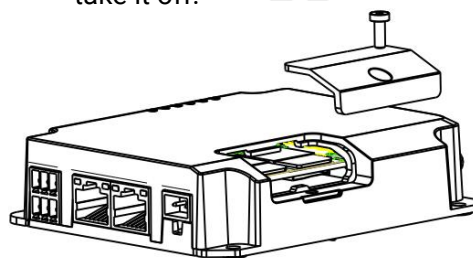

#### 3.2 Antenna Installation

Rotate the antenna into the antenna connector accordingly.

The external antenna should be installed vertically always on a site with a good signal.

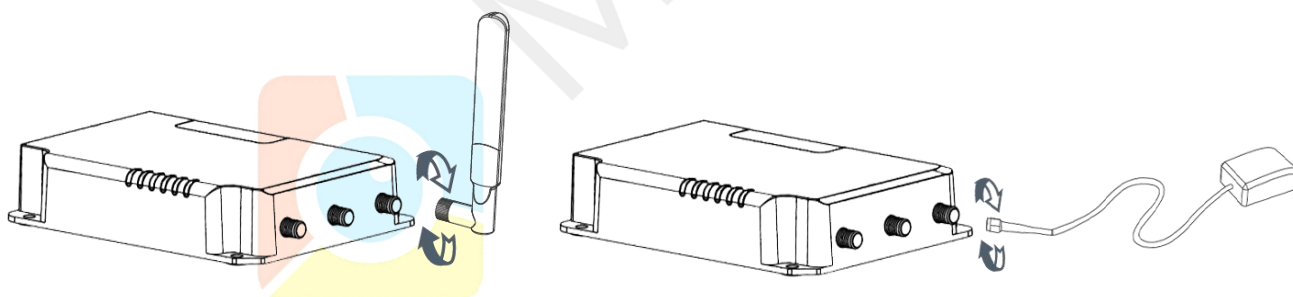

#### 3.4 Router Installation

The router can be placed on a desktop or mounted to a wall or a DIN rail.

##### 3.4.1 Wall Mounting (Measured in mm)

Use 4 pcs of M3 × 6 flat head Phillips screws to fix the router on the wall.

**⚠ Recommended torque for mounting is 1.0 N·m, and the maximum allowed is 1.2 N·m.**

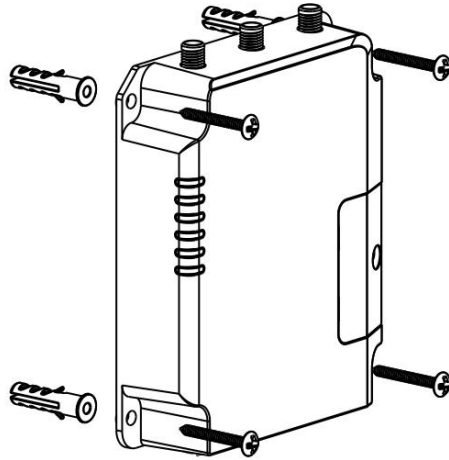

### 3.4.2 DIN Rail Mounting (Measured in mm)

Use 2 pcs of M3 × 6 flat head Phillips screws to fix the DIN rail to the router, and then hang the DIN rail on the mounting bracket. It is necessary to choose a standard bracket.

**⚠ Recommended torque for mounting is 1.0 N·m, and the maximum allowed is 1.2 N·m.**

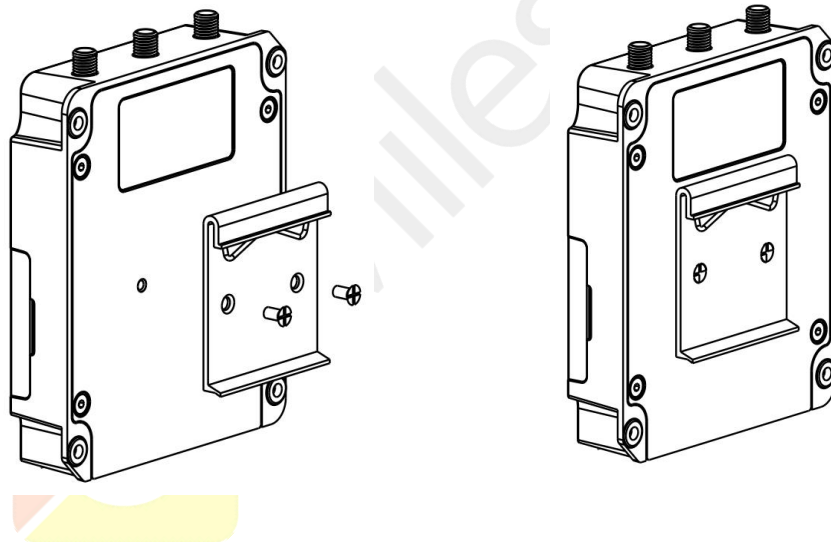



## 4. Log in the Web GUI of Router

### 4.1 PC Configuration

Please connect PC to LAN port of UR32 router. PC can obtain an IP address, or you can configure a static IP address manually. The following steps are based on Windows 10 operating system for your reference.

**(Note:** As remote access is disabled by default, you can't access to the router's Web GUI if you connect PC to WAN port of the router. But it will function properly if you enable it on Web GUI.)

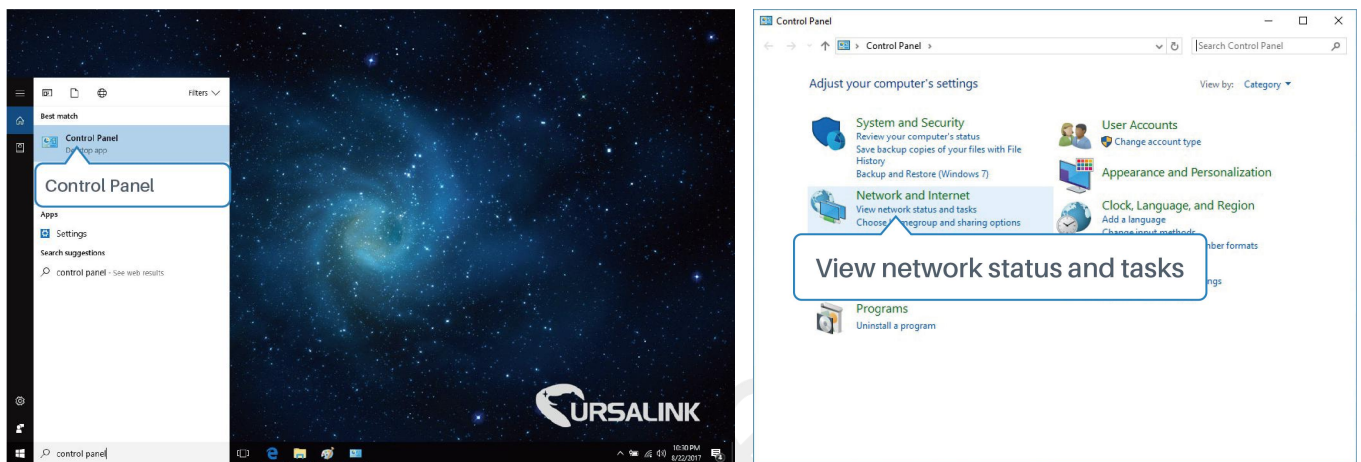

- ① Click "Search Box" to search "Control Panel" on the Windows 10 taskbar.
- ② Click "Control Panel" to open it, and then click "View network status and tasks".

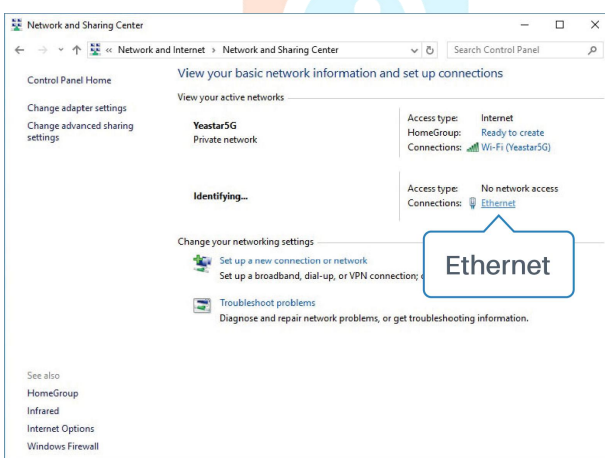

- ③ Click "Ethernet" (May have different names).

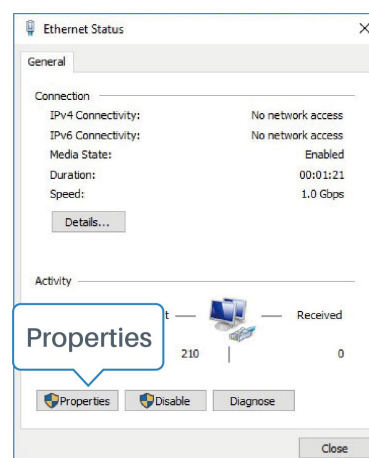

- ④ Click "Properties".

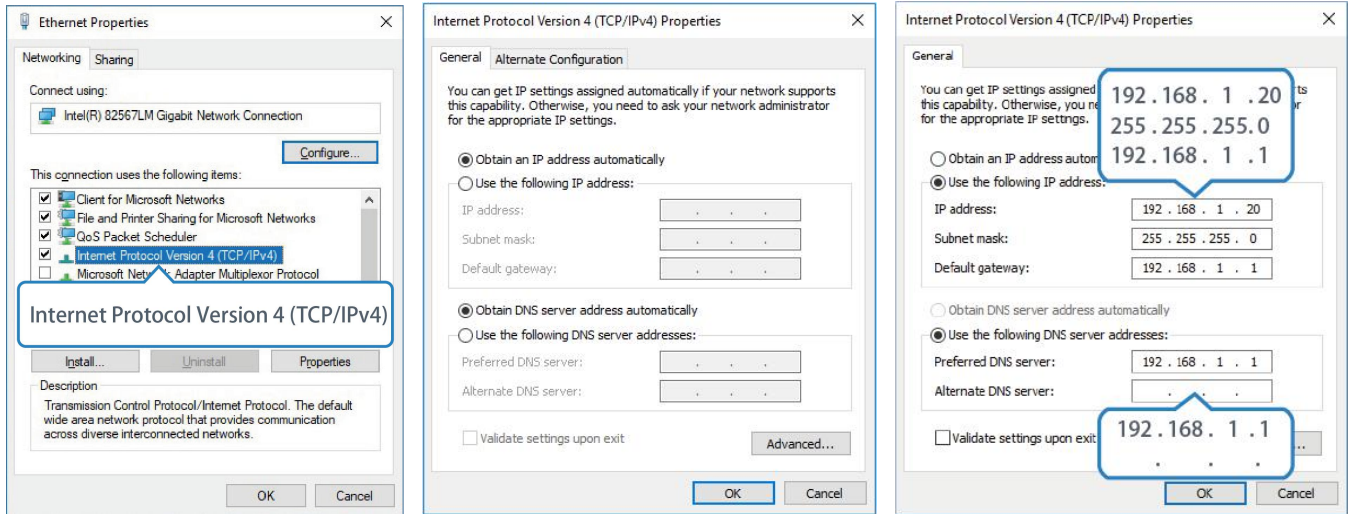

⑤ Double Click “Internet Protocol Version 4 (TCP/IPv4)” to configure IP address and DNS server.

⑥ Method 1: click “Obtain an IP address automatically”;

Method 2: click “Use the following IP address” to assign a static IP manually within the same subnet of the router.

(Note: Remember to click “OK” to finish configuration.)

## 4.2 Log in the Router

If this is the first time you configure the router, please use the default settings below:

IP Address: **192.168.1.1**

Username: **admin**

Password: **password**

- A. Start a Web browser on your PC (Chrome is recommended), type in the IP address, and press Enter on your keyboard.
- B. Enter the username and password, click “Login”.

English



 If you enter the username or password incorrectly more than 5 times, the login page will be locked for 10 minutes.

C. When you log in with the default username and password, you will be asked to modify the password. It's suggested that you change the password for the sake of security. Click "Cancel" button if you want to modify it later.

**Change Password** ✕

Old Password

New Password

Confirm New Password

Save
Cancel

D. After you log in the Web GUI, you can view system information and perform configuration on the router.

For your device security, please change the default password!

Status	Overview	Cellular	Network	VPN	Routing	Host List	GPS	Help	
Network	System Information		System Status						<b>Model</b> Show the model name of router. <b>Serial Number</b> Show the serial number of router. <b>Firmware Version</b> Show the current firmware version of router. <b>Hardware Version</b> Show the current hardware version of router. <b>Local Time</b> Show the current local time of system. <b>Uptime</b> Show the information on how long the router has been running. <b>CPU Load</b> Show the current CPU utilization of the router. <b>RAM (Available/Capacity)</b> Show the RAM available and the capacity RAM memory. <b>Flash (Available/Capacity)</b> Show the Flash available and the capacity Flash memory. <b>Current SIM</b> Show the SIM card capacity.
System	Model	UR32-L01CE-G	Local Time	2020-04-30 14:40:08 Thursday					
Industrial	Serial Number	621892450159	Uptime	00:03:41					
Maintenance	Firmware Version	32.2.0.5	CPU Load	9%					
APP	Hardware Version	V1.1	RAM (Available/Capacity)	39MB/128MB(30.47%)					
			Flash (Available/Capacity)	91MB/128MB(71.09%)					
	Cellular		WAN <span style="color: green;">● Link in use</span>						
	Status	No SIM Card	Status	Online					
	Current SIM	SIM2	IP	192.168.22.225					
	IP	0.0.0.0	MAC	24:e1:24:f0:31:94					
	Connection Duration	0 days, 00:00:00	Connection Duration	0 days, 00:02:34					
	Data Usage Monthly	0.0 MIB							
	LAN								
	IP	192.168.0.1							
	Connected Devices	0							
<span style="border: 1px solid #007bff; padding: 2px 5px; font-size: x-small;">Manual Refresh</span> <span style="border: 1px solid #007bff; padding: 2px 5px; margin-left: 5px;">Refresh</span>									

## 5. Network Configuration

This chapter explains how to connect UR32 to network via WAN connection or cellular.

### 5.1 Ethernet WAN Configuration

A. Go to “Network > Interface > Port” to change LAN1 to WAN port.

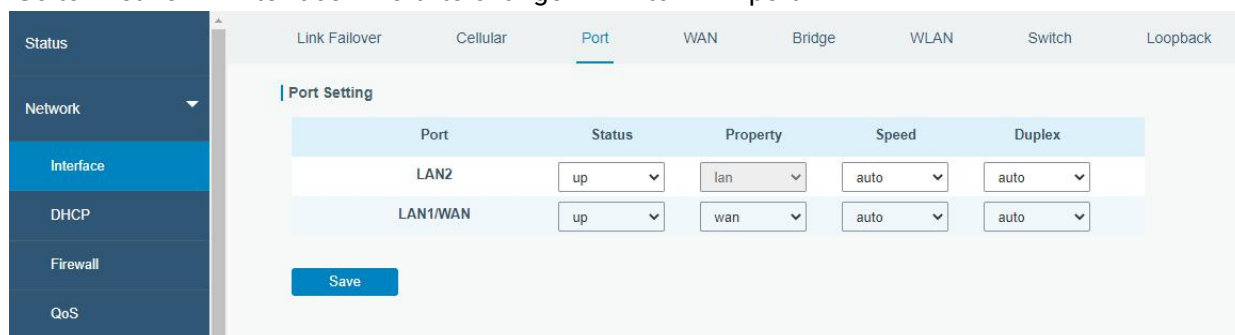

B. Go to “Network > Interface > WAN” to configure WAN parameters. Take static IP configuration as an example. DHCP client and PPPoE type are optional according to your requirements.

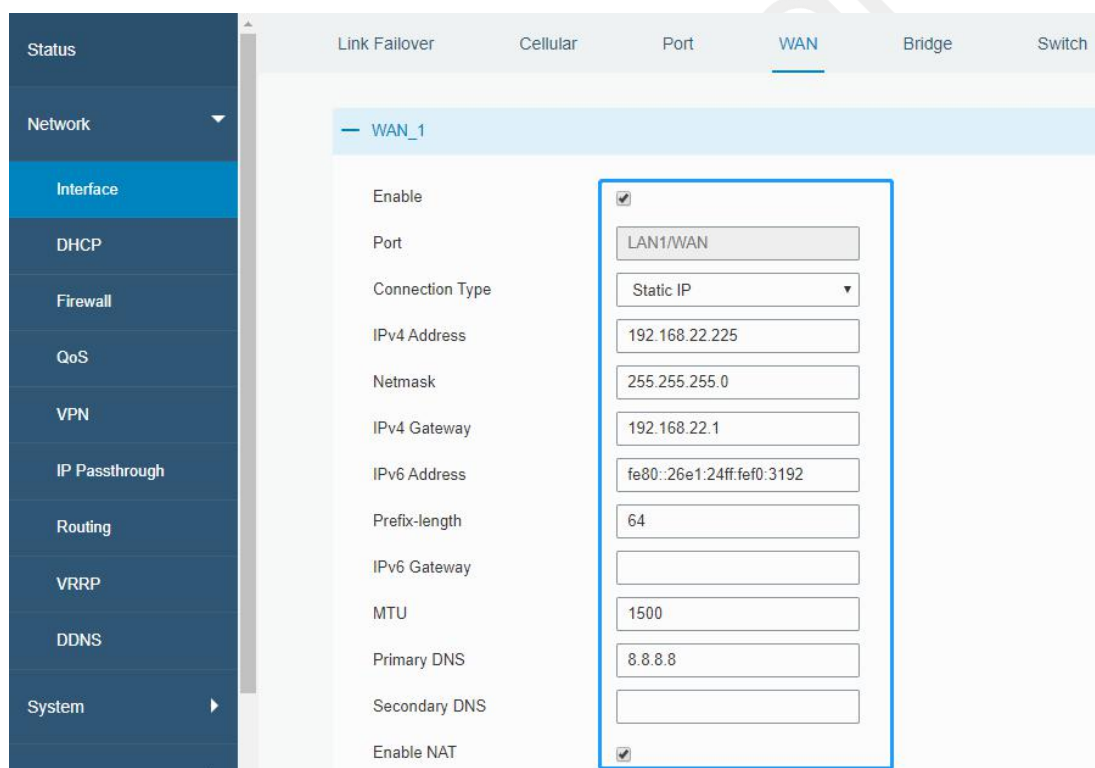

Click “Save & Apply” button to make the changes take effect.

C. Connect WAN port to another router or modem.

D. Log in UR32 web GUI via WAN port IP address and go to “Status > Network” to check if status is “up”.



E. Go to “Network > Interface > Link Failover” to rise the WAN priority to 1.

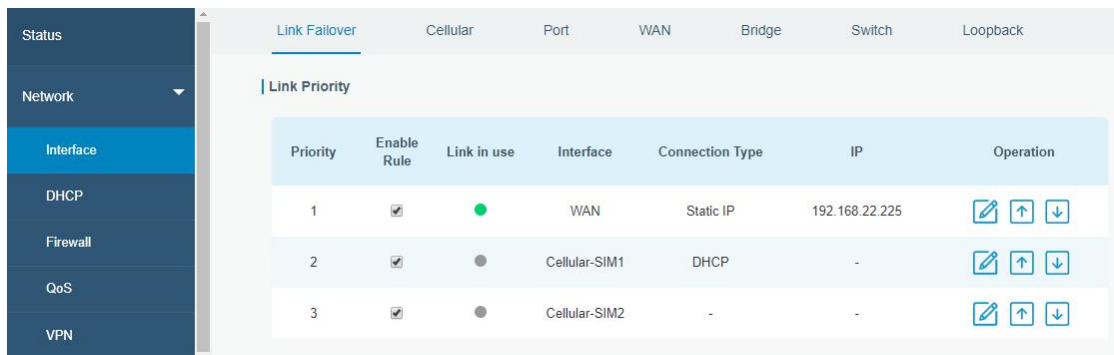

F. Open your preferred browser on PC, then type any available web address into address bar and see if it is able to visit Internet via UR32 router.

## 5.2 Cellular Connection Configuration

Take inserting SIM card into SIM1 slot as an example; please refer to the following detailed operations.

- Click “Network > Interface > Cellular > Cellular Setting” to configure the cellular info, like APN and network type.
- Click “Save” and “Apply” for configuration to take effect.

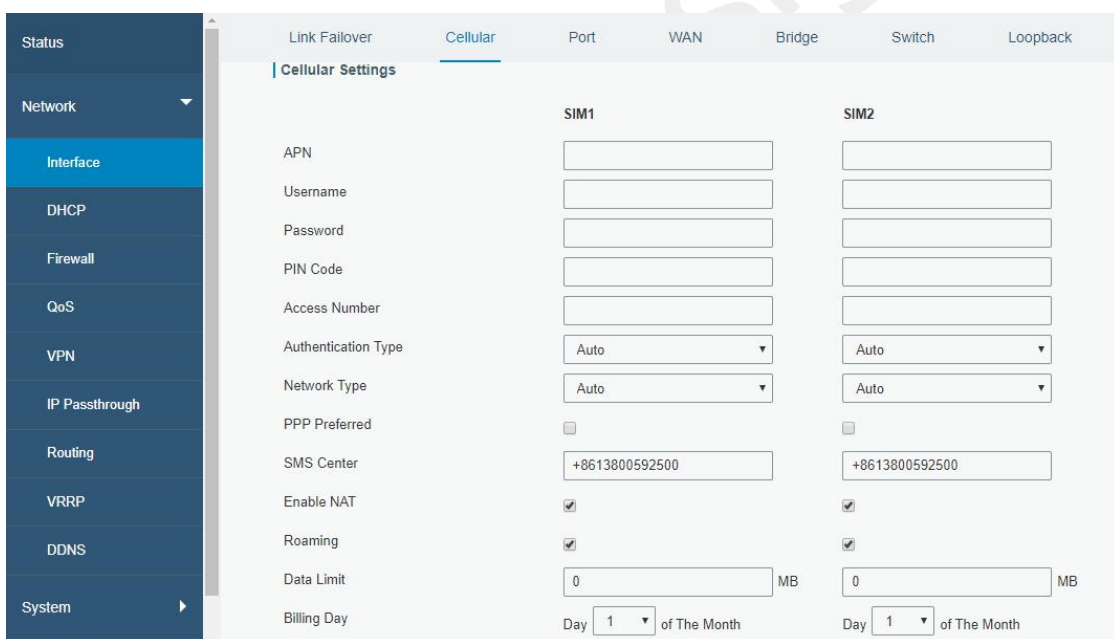

If you select “Auto”, the router will obtain ISP information from SIM card to set APN, Username, and Password automatically. This option will only be taken effect when the SIM card is issued from a well-known ISP.

C. Go to “Network > Interface > Link Failover” to enable SIM1 and rise link priority of SIM1.

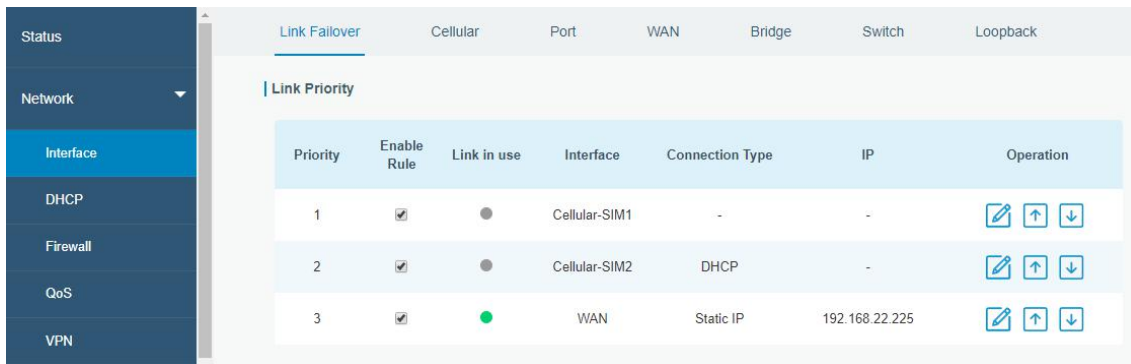

D. Click to configure ICMP ping detection information.

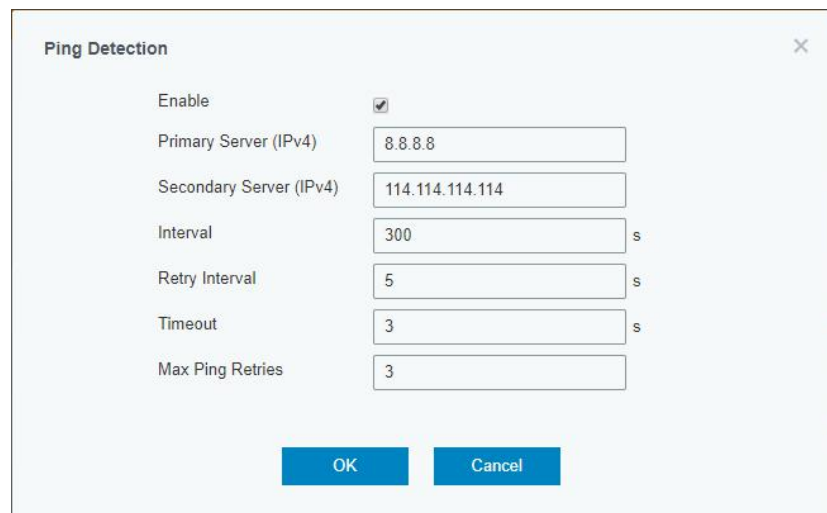

E. Click "Status > Cellular" to view the status of the cellular connection. If it shows "Connected", it means SIM1 has dialed up successfully. On the other hand, you can check the status of SIM indicator. If it keeps on green light statically, it means SIM1 has dialed up successfully.

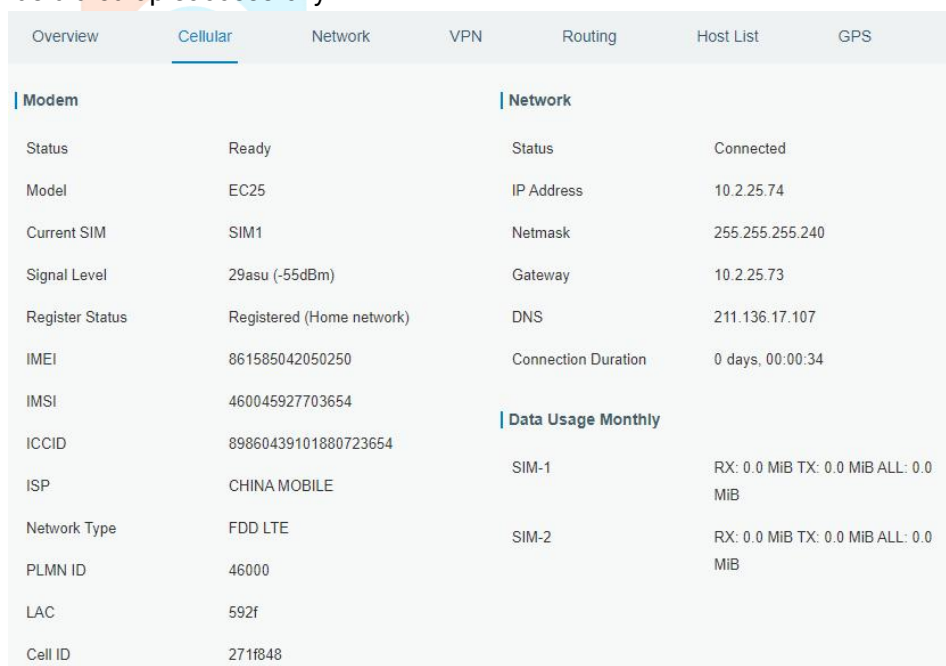

F. Open your preferred browser on PC, then type any available web address into address bar and see if it is able to visit Internet via UR32 router.

**[END]**



Milesight